

THUNDERBLADE™

INSTRUCTIONS



TM

The NES Files

<http://www.nesfiles.com>

Thank you for selecting the fun-filled "THUNDERCADE" game pak by AMERICAN SAMMY CORPORATION.



THIS GAME IS
LICENSED BY NINTENDO®
FOR PLAY ON THE



NINTENDO AND Nintendo **ENTERTAINMENT SYSTEM**
ARE TRADEMARKS OF NINTENDO OF AMERICA INC.

This official seal is your assurance that Nintendo® has reviewed this product and that it has met our standards for excellence in workmanship, reliability and entertainment value. Always look for this seal when buying games and accessories to ensure complete compatibility with your Nintendo Entertainment System®

The NES Files

1
<http://www.nesfiles.com>

SAFETY PRECAUTIONS

Please take time to read the important instructions in this booklet. Observing the step by step instructions and complying with warnings will be your personal guarantee to greater game satisfaction over a long period of time.

- 1) Avoid subjecting this high precision Game Pak to extreme temperatures and shock. Furthermore, never attempt to disassemble your game pak
 - 2) Do avoid touching the connectors. Store the game pak in its protective STORAGE case.
 - 3) Use of thinners, solvents, benzene, alcohol and other cleaning agents can damage the game pak.
 - 4) Pause for 10-15 minutes after 2 hours or more of continuous game playing. This will extend the life of your game pak.
- *Please note that this game has been programmed to take advantage of the full screen. Some older models have rounded screens and may block out a portion of the image.*

The NES Files

2

<http://www.nesfiles.com>

1. GAME STORY

Terrorism has reached new heights. AATOM (Atomic Age Terrorist Organization of Miracali) has constructed their own nuclear power plant, and threaten the world with atomic terror.

The world powers have decided to initiate operation THUNDERCADE to stop AATOM. Equipped with a high-performance combat motorcycle, sidecar cannons, and backed by a precision B-7 bomber, you set out on the dangerous mission.

The wind rages through your hair as your cycle charges into enemy territory. Your sidecar cannons unleash a storm of hot metal rounds, shredding tank armor and shattering concrete. When the going gets rough, you call in air support and let the flyboys wipe'em out. Through city streets, forests, and strongholds you fight, but can you make it to the fortress and save the world?

2. CONTROLLER PARTS AND OPERATING INSTRUCTIONS

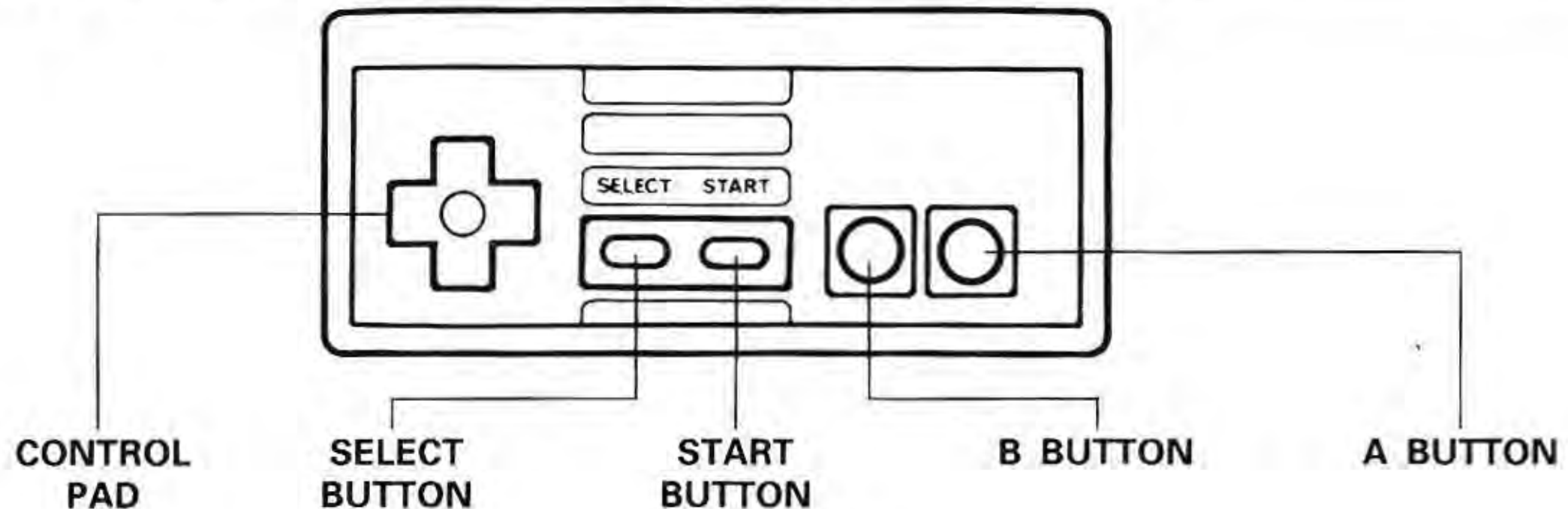

- Use the control pad to move the combat cycle.
- Press the A button to bomb.
- Press the B button to fire cannons.

SELECT BUTTON

Determine the number of players on the title screen by pressing the Select button.

1 PLAYER — For individual play.

2 PLAYERS — For simultaneous play.

START BUTTON

Press the Start button to begin the game.

<<PAUSE FUNCTION>>

If you wish to pause during a game, press the Start button. Press the Start button again to continue play.

3. DISPLAY DESCRIPTION

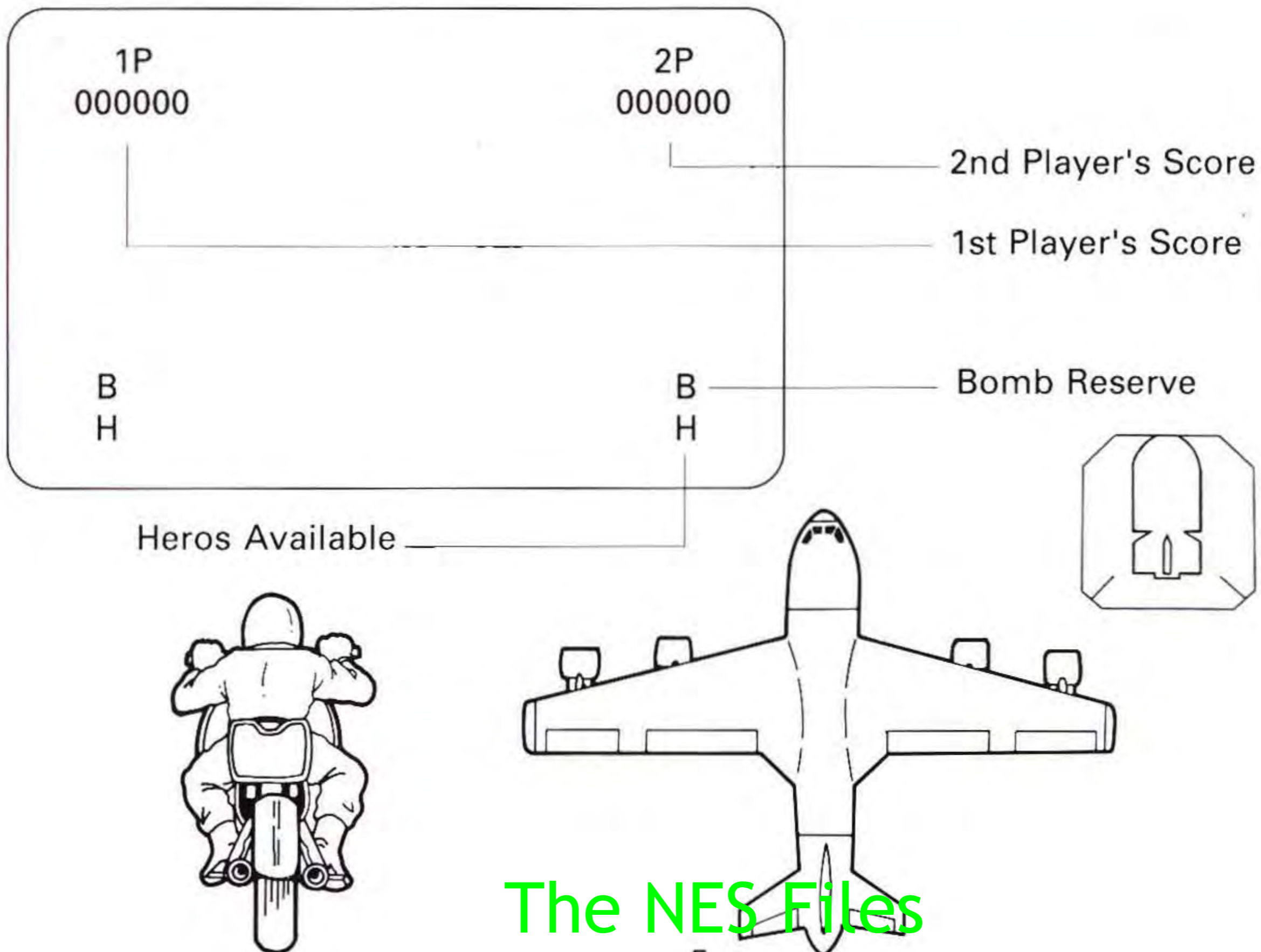

4. HOW TO PLAY

THUNDERCADE consists of four zones: the city, the base, the woodland and the fortress. With a combat cycle and air support, you have to battle your way through these zones and destroy the nuclear power plant — your final objective.

Your combat cycle is equipped only with a machine gun. To increase your firepower, side cars can be added to the cycle. While fighting, look for these extra cannons along your route. Some will appear in the open, while others will be hidden in buildings, greenery, or other obstacles.

Be careful! Not all obstacles can be destroyed, and if you run into some of them, you may crash.

Your combat cycle will automatically jump before water pools, inclines and dirt hills. While jumping, you can move to the left or right, but cannot slow down. You can also easily slip above enemy fire while in the air, but are vulnerable as soon as you land.

You have three heros, each with three bombs in their reserve, at the beginning of the game. When you encounter many enemies or an exceptionally difficult one, you can use the bombs for more firepower. Available bombs and heros remaining are shown at the lower part of each player's side of the screen.

If all heros are eliminated, the game will end. Up to the tunnel at the end of the third zone, you can continue the game twice. Once you go through the tunnel, you are allowed another continuation.

The NES Files

6
<http://www.nesfiles.com>

5. CONTINUE OPTION

THUNDERCADE offers the player the option to continue a game after all heros have been eliminated. Pressing any button on the control pad during the continuation countdown will start a new game at the beginning of the area where the last hero was eliminated.

In two-player mode, when the longest surviving player loses all heros, any button on the controller can be pressed before the end of the countdown to continue the game for both players.

If you clear the tunnel at the end of the third zone, you secure another continuation.

Scores obtained in previous stages are not carried over into the continued game.

6. SIDE CARS

Various types of side cars appear in the battle scene, each of them having different capabilities. Pick them up to power up your combat cycle. If you have side cars already, new side cars replace the old ones. Some of the side cars appear on the ground, but some are hidden in obstacles, thus, to pick up the side cars, you must destroy the obstacles.

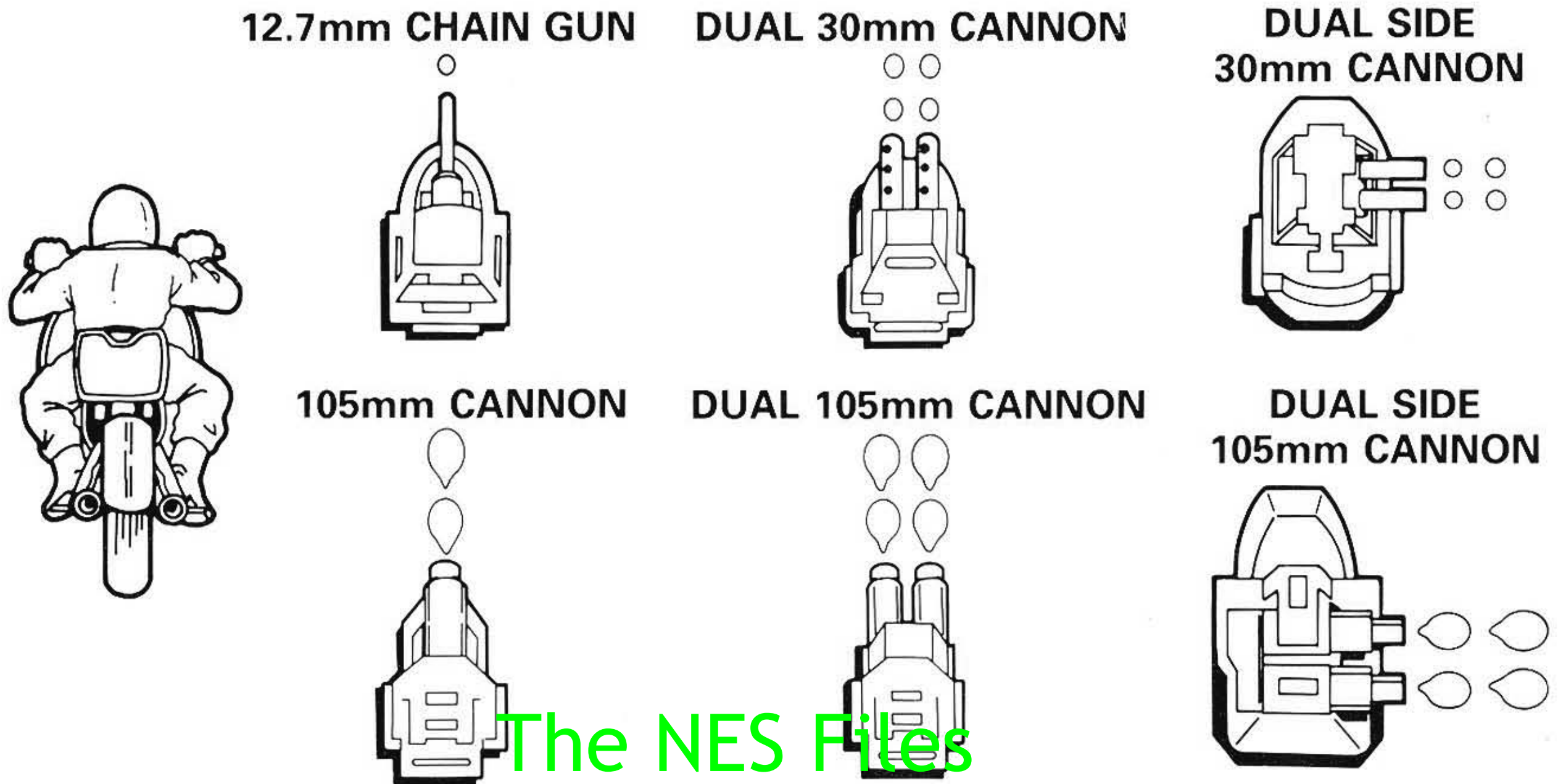

7. AIR SUPPORT

Against heavy enemy forces, a tough strategic target, or any situation too hot to handle, remember that you have a B-7 bomber providing air support, just press the "B" button on your controller.

Each hero starts with three bombs in his bomb reserve. If you pick up a bomb (see "items" page 11), it will be added to your stock. The number of bombs in the reserve is displayed as 'B:3' (in this example, there are three bombs) at the lower corner of each player's side.

The hero's position and bomb timing are critical, since the bombs only destroy what they hit.

Pressing the "B" button within the first two seconds of the first bombing extends the target range and doubles bombing area.

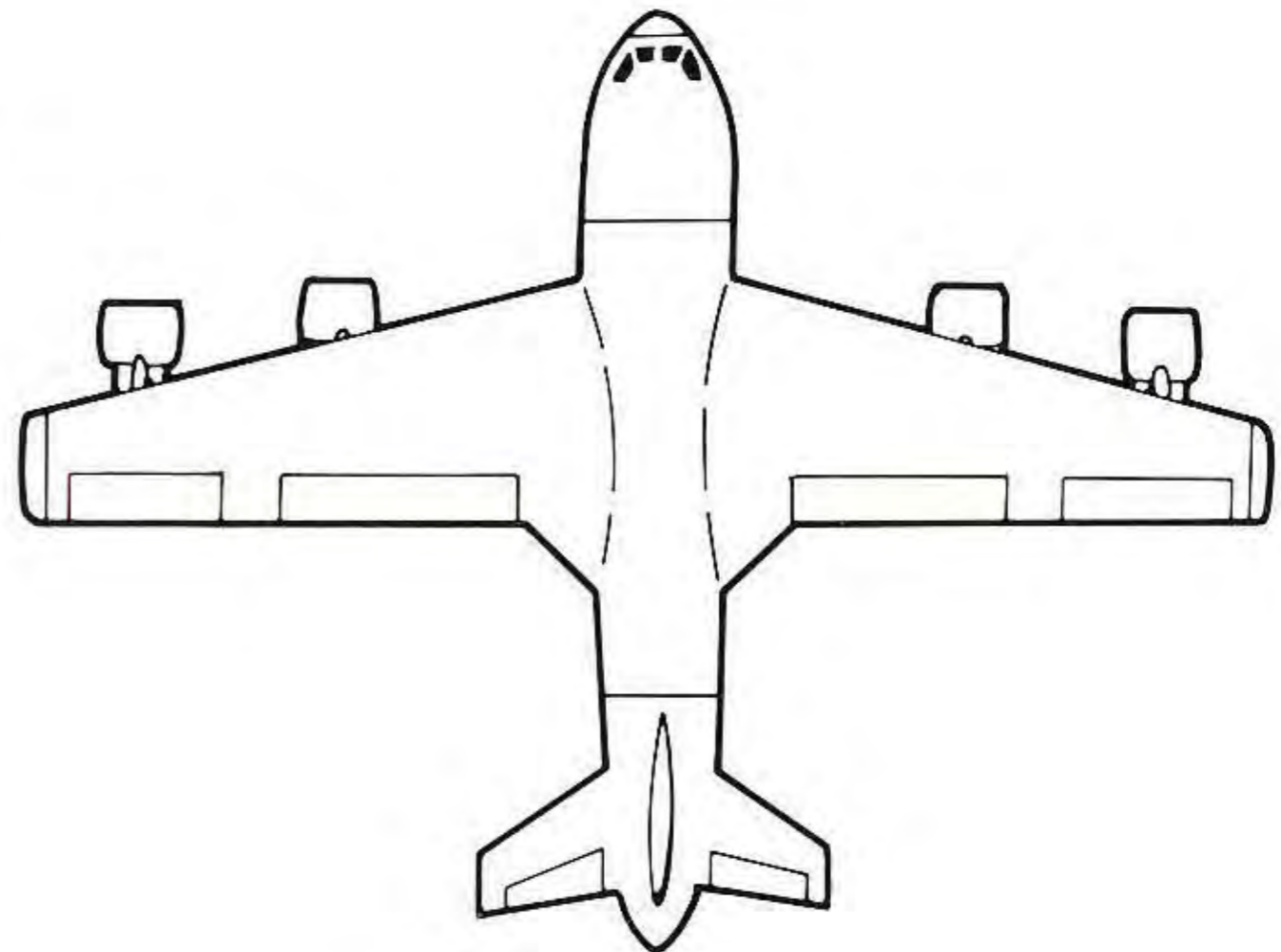

8. BONUS STAGE

If you secure a bonus item at the end of zone 1 or zone 2, or safely go through the tunnel at the end of zone 3, you can play the bonus stage.

While in two player mode, if either player enters the tunnel, both will receive bonus play.

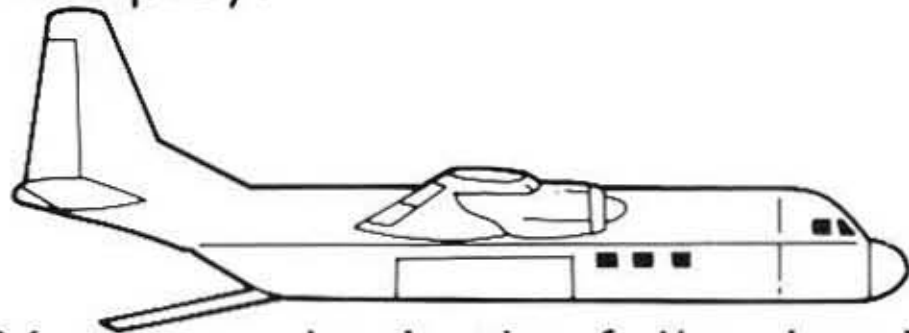

In the bonus stage, a sky truck appears and drops supplies. By driving your bike back and forth, you should secure as many of them as you can.

You can obtain the following items in this stage:

BOMB

(see "items" page 11)

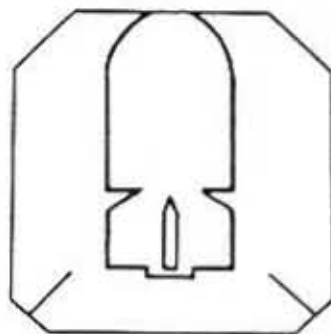

ONE-UP

(see "items" page 11)



VULCAN CANNON

(see "items" page 11)



PARACHUTE

Each parachute carries four missiles. Missiles as well as bullets are fired by pressing the B button.

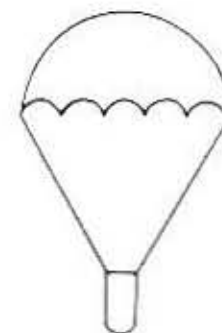

After the completion of the bonus stage, the screen displays a list of items obtained.

The NES Files

9. ITEMS



BONUS STAGE ITEM

These items appear if the gunships are destroyed within a certain period of time. You can play the bonus stage by securing this item. In a two-player game, the bonus game can be played only by the player who obtains the bonus item first.



VULCAN CANNON

This item can be captured in the battle field or bonus stage. If you secure this item, the Vulcan cannon system is connected to your combat cycle.

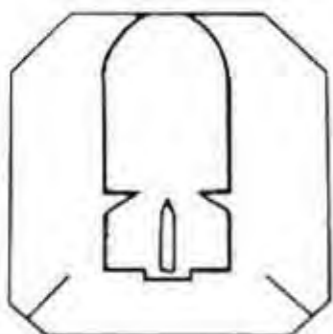

BOMB

This is an item for air support. The bomb can be obtained in the battlefield or during the bonus stage, and is stored in your bomb reserve.



ONE-UP

Player gains one extra hero.

The NES Files

<http://www.nesfiles.com>

10. PERFORMANCE-ANALYSIS DISPLAY

This display appears when the game is over or a zone is cleared. It lists shots fired, the number of hits, the hit ratio, and displays a progression map.

SCREEN EXAMPLE

1P	HIGH SCORE	2P
000000	000000	000000
SHOT FIRED	0000	
NUMBER OF HITS	000	
HIT-MISS RATIO	00 %	
CITY	BASE	
<input type="text"/>		
WOOD LANDS	FORTRESS	
<input type="text"/>		

These figures can help you better your score and game performance, and judge the distance to the final objective.

The NES Files

12
<http://www.nesfiles.com>

11. HINTS

- When fighting large targets (Gunships, Submarines, etc.), use both the cycle cannons and bombs.
- Destroy as many obstacles as possible, for you may find valuable tokens or side cars in them.
- Enemy bullets cannot harm you when jumping, however, watch your landing!
- When you have a favored side car cannon, don't touch any others or you may lose it.
- Most enemy attacks can be stopped by bombing.
- Using a joystick with rapid-fire will improve your fire-power.

The NES Files

<http://www.nesfiles.com>

12. ENEMIES

GREEN SOLDIER

(100 points)



RED SOLDIER

(500 points)



ARMORED MOBILE

Rocket Launcher

(1,500 points)

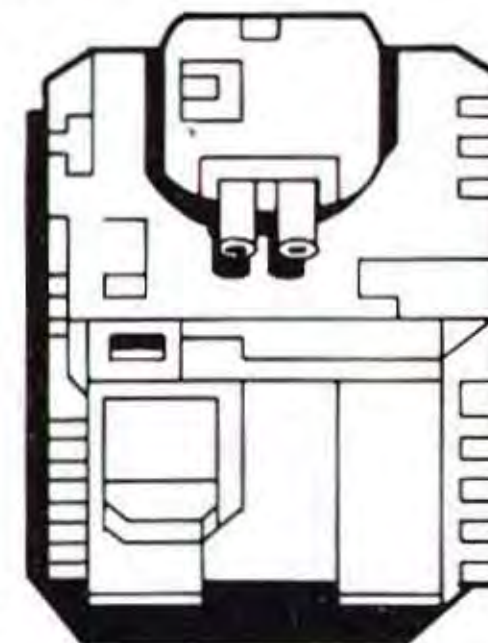

LIGHT TANK (green)

(500 points)

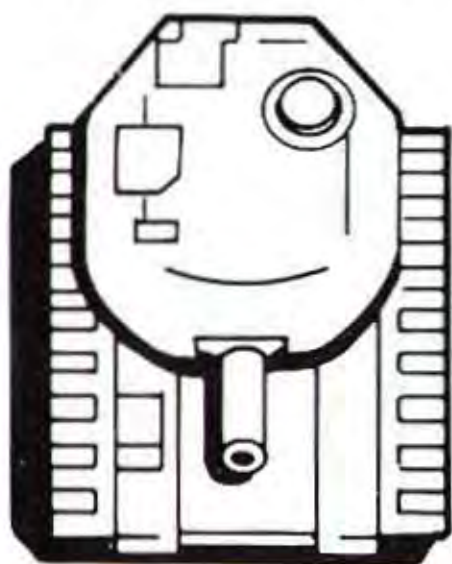

HEAVY TANK (pink)

(1,000 points)

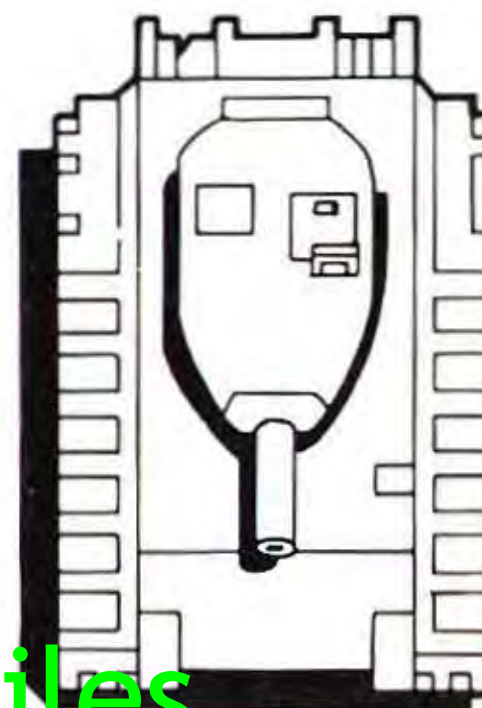

The NES Files

CHOPPER

(800 points)



JET FIGHTER

(1,500 points)

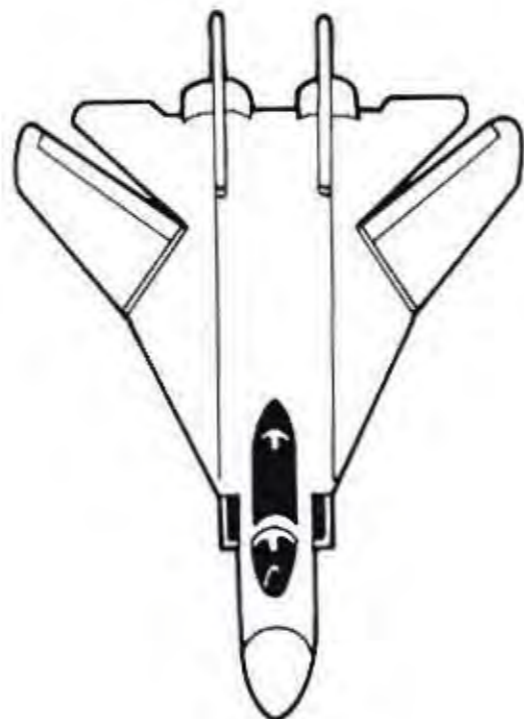

PILLBOX

(up to woodlands 1,500 points
after woodlands 2,000 points)



MISSILE

(1,500 points)



MISSILE LAUNCHING PAD

(500 points)

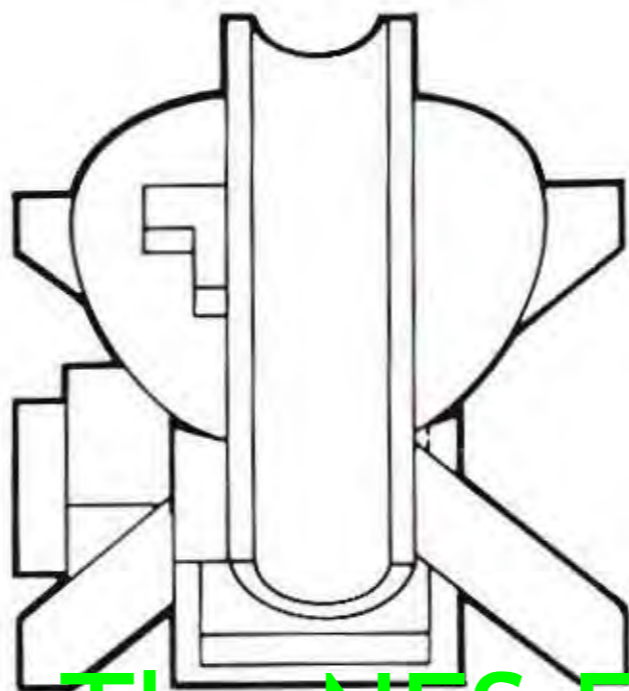

ROCKET LAUCHER

(2,000 points)

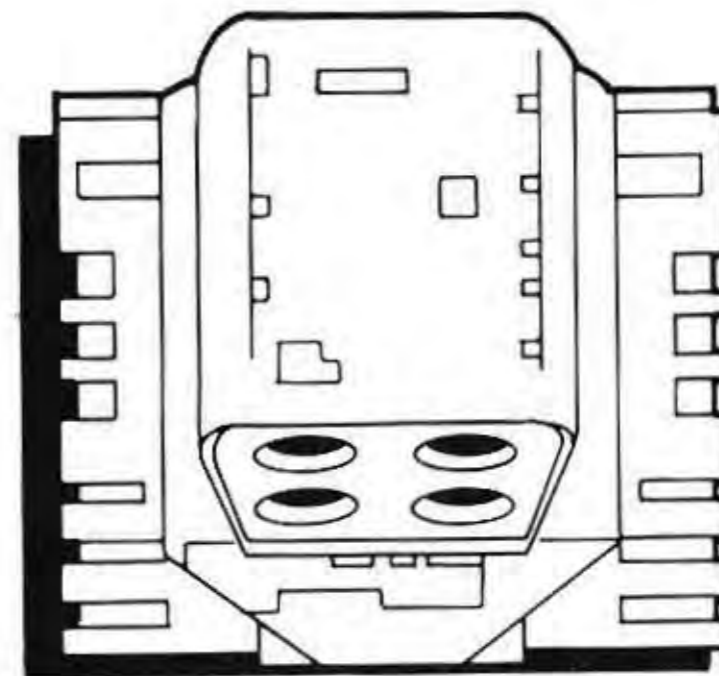

The NES Files

STRATEGIC TARGETS

Submarines and gunships have one or more strike zones. When confronted with these mammoth enemies, combination attacks with guns and bombs are most effective.

SUBMARINE

(5,000 points)

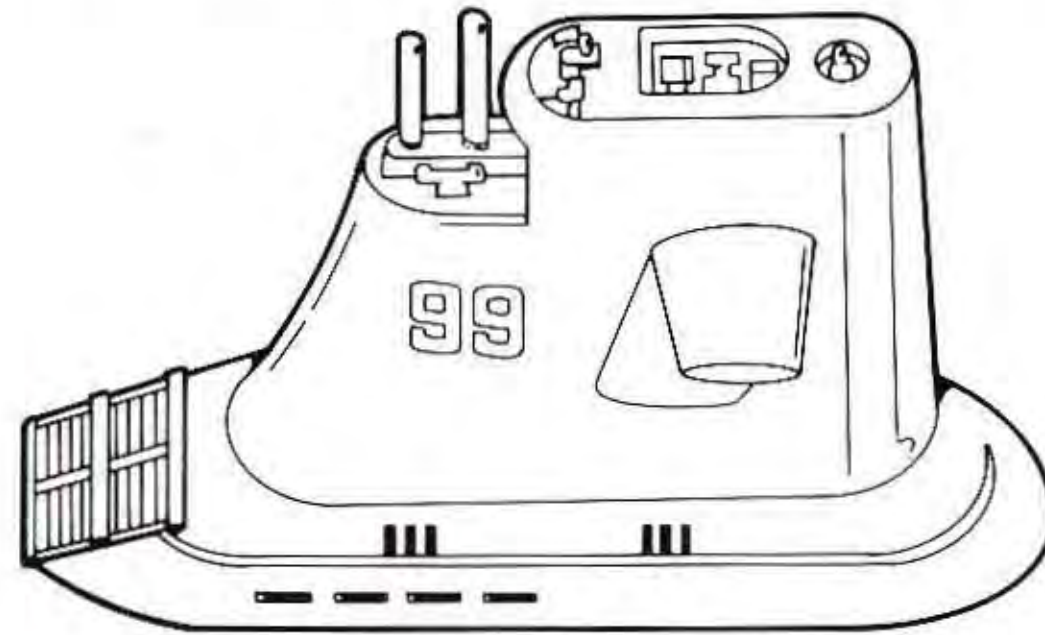

GUN SHIP

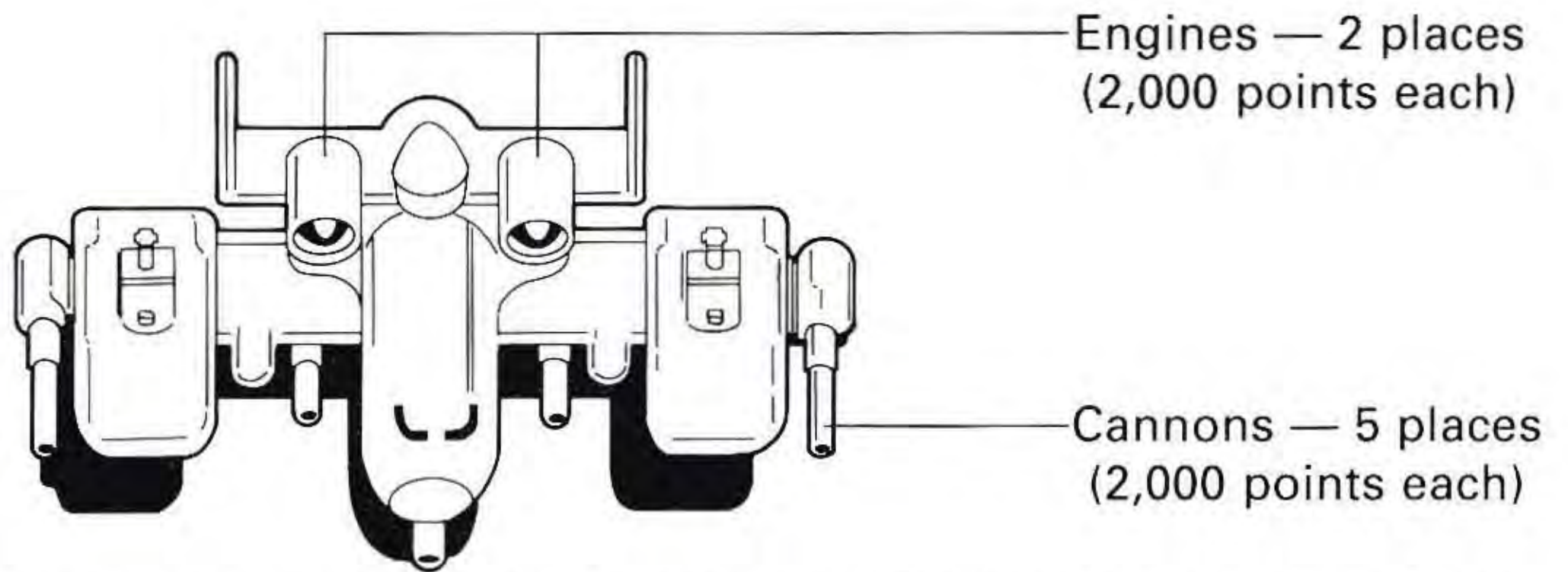

* If you completely destroy the gunship, 10,000 points will be added to your score.

The NES Files

NUCLEAR POWER PLANT

This is the final objective of the game.

There are ten windows in the plant, and snipers are firing from each window. You must destroy them one by one.

Upon destroying all windows, the power plant explodes and you have completed your mission.

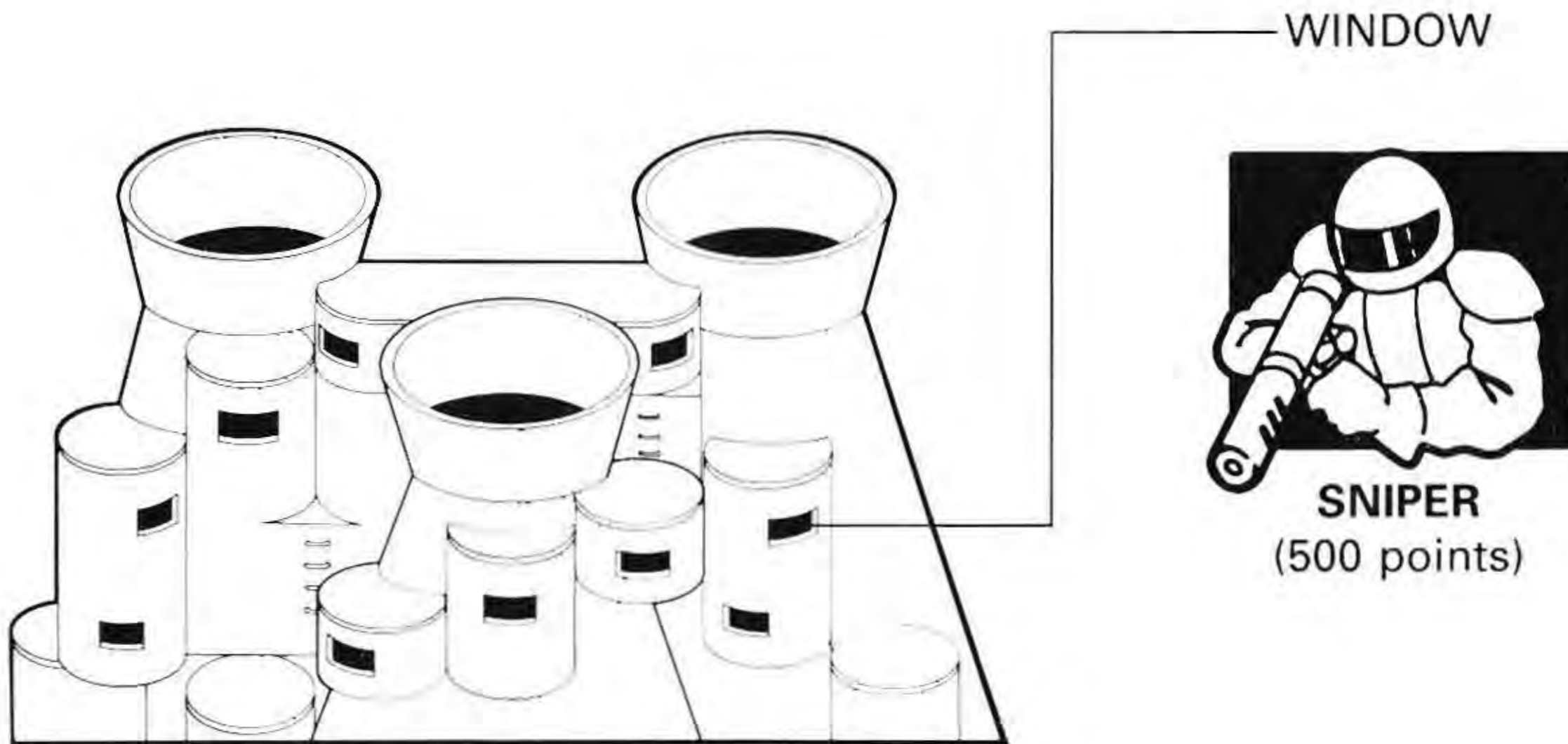

The NES Files

17

<http://www.nesfiles.com>

13. OBSTACLES

SUPPLY TRUCK

(1,000 points)

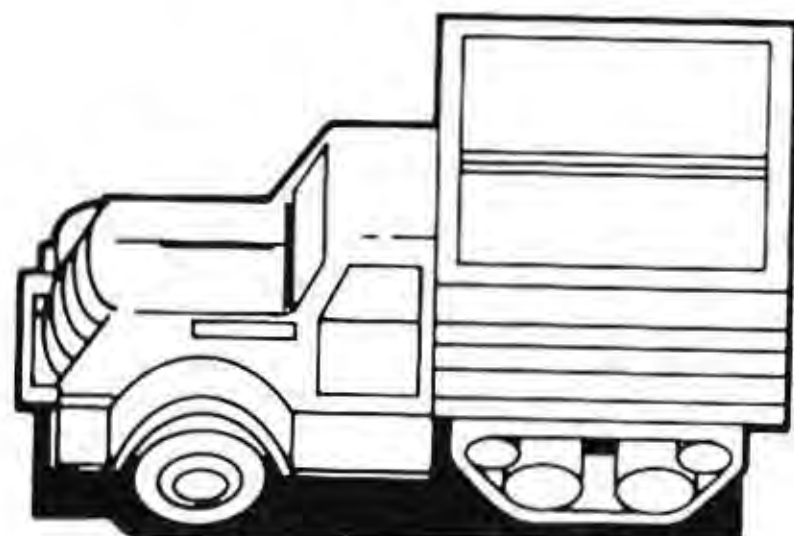

GAS DRUM

(200 points)



6 GAS DRUMS

(1,000 points)



BUILDING

(2,000 points)

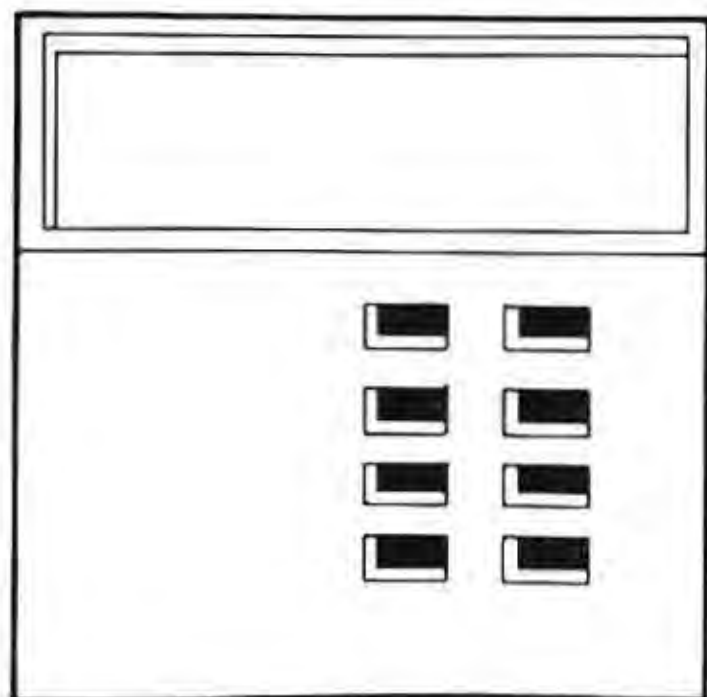

GREENERY

(500 points)

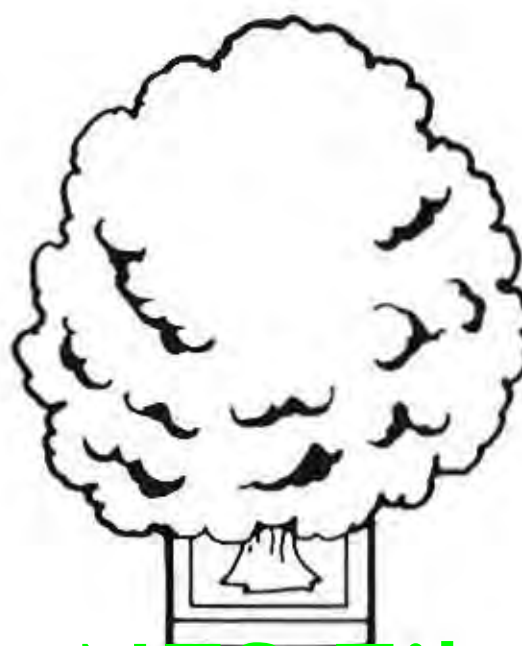

CACTUS

(100 points)



The NES Files

MINE
(0 points)

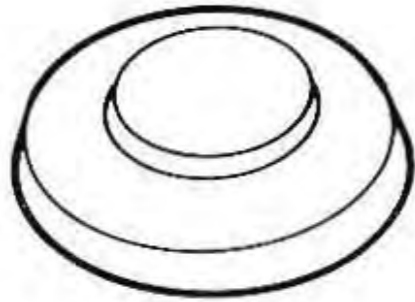

LAUNCHING PAD
(2,000 points)

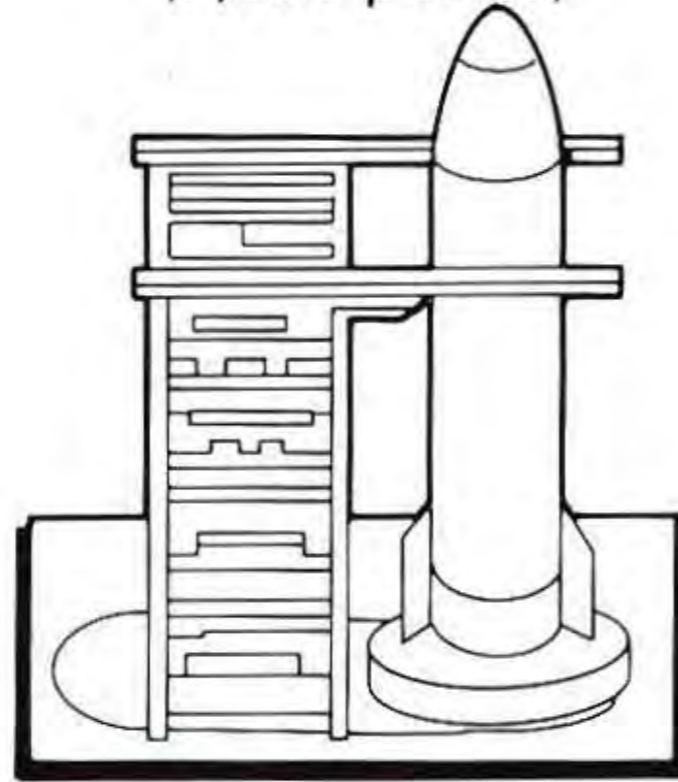

HELICOPTER
(1,000 points)

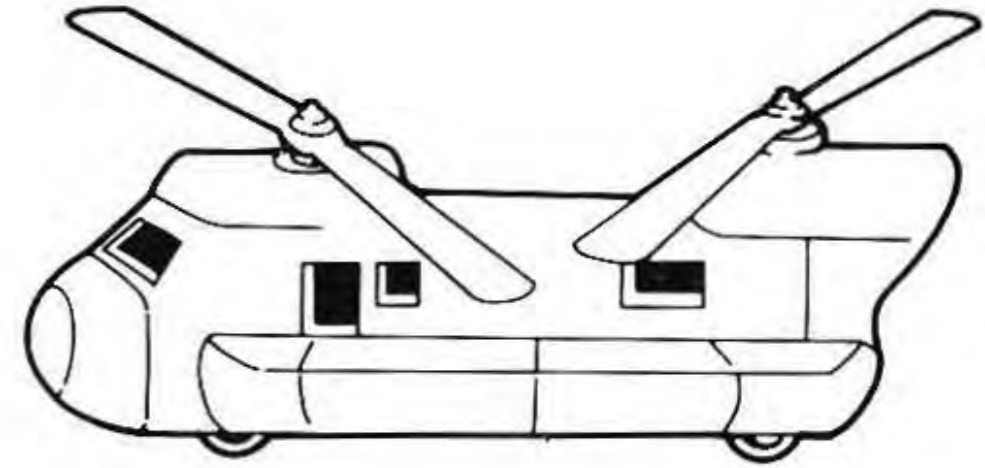

INFANTRY INSTALLATION
(2,000 points)

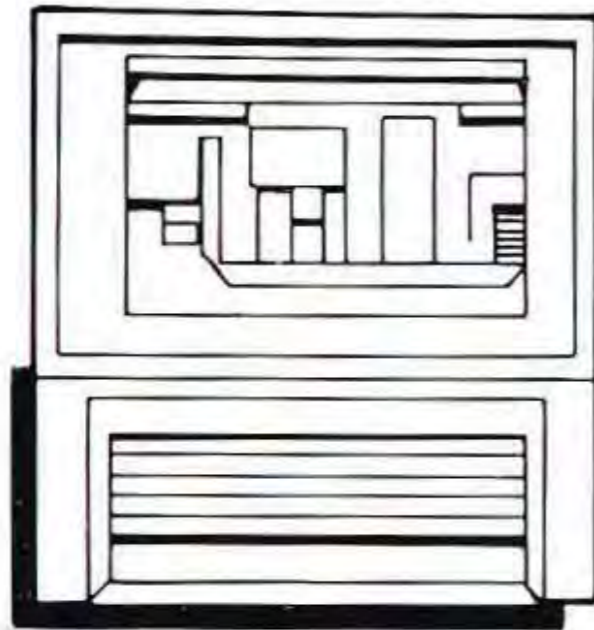

GATE
(2,000 points)



DIRT HILL
(2,000 points)



The NES Files

19
<http://www.nesfiles.com>

MEMO

90-DAY LIMITED WARRANTY AMERICAN SAMMY GAME PAKS

90-DAY LIMITED WARRANTY:

American Sammy Corporation ("American Sammy") warrants to the original consumer that this AMERICAN SAMMY Game Pak ("PAK") (not including Game Pak Accessories or ROBOT ACCESSORIES) shall be free from defects in material and workmanship for a period of 90 days from date of purchase. If a defect covered by this warranty occurs during 90-day warranty period, American Sammy will repair or replace the PAK, at its option, free of charge.

To receive this warranty service:

1. DO NOT return your defective Game Pak to the retailer.
2. Notify the American Sammy Division of the problem requiring warranty service by calling: (213) 320-7167.
3. If the American Sammy service technician is unable to solve the problem by phone, he will provide you with a Return Authorization number. Simply record this number on the outside packaging of your defective PAK, and return your PAK freight prepaid, at your risk of damage, together with your sales slip or similar proof-of-purchase within the 90-day warranty period to:

American Sammy Corporation Consumer Division
2421 205th Street, Suite D-104, Torrance, CA 90501

This warranty shall not apply if the PAK has been damaged by negligence, accident, unreasonable use, modification, tampering, or by other causes unrelated to defective materials or workmanship.

REPAIRS AFTER EXPIRATION OF WARRANTY:

If the PAK develops a problem after the 90-day warranty period, you may contact American Sammy Consumer Service Division at the phone number noted above. If the American Sammy service technician is unable to solve the problem by phone, he may provide you with a Return Authorization number. You may then record this number on the outside packaging of the defective PAK and return the defective PAK freight prepaid to American Sammy, enclosing a check or money order for \$10.00 payable to American Sammy Corporation. American Sammy will, at its option, subject to the conditions above, repair the PAK or replace it with a new or repaired PAK. If replacement PAKS are not available, the defective PAK will be returned and the \$10.00 payment refunded.

WARRANTY LIMITATIONS:

ANY APPLICABLE IMPLIED WARRANTIES, INCLUDING WARRANTIES OF MERCHANTABILITY AND FITNESS FOR A PARTICULAR PURPOSE, ARE HEREBY LIMITED TO NINETY DAYS FROM THE DATE OF PURCHASE AND FOR A PARTICULAR PURPOSE, ARE HEREBY LIMITED TO NINETY DAYS FROM THE DATE OF PURCHASE AND ARE SUBJECT TO THE CONDITIONS SET FORTH HEREIN. IN NO EVENT SHALL AMERICAN SAMMY BE LIABLE FOR CONSEQUENTIAL OR INCIDENTAL DAMAGES RESULTING FROM THE BREACH OF ANY EXPRESS OR IMPLIED WARRANTIES.

The provisions of this warranty are valid in the United States only. Some states do not allow limitations on how long an implied warranty lasts or exclusion, of consequential or incidental damages, so the above limitations and exclusion may not apply to you. This warranty gives you specific legal rights, and you may also have other rights which vary from state to state.

COMPLIANCE WITH FCC REGULATIONS

This equipment generates and uses radio frequency energy and if not installed and used properly, that is, in strict accordance with the manufacturer's instructions, may cause interference to radio and television reception. It has been type tested and found to comply with the limits for a Class B computing device in accordance with the specifications in Subpart J of Part 15 of FCC Rules, which are designed to provide reasonable protection against such interference in a residential installation. However, there is no guarantee that interference will not occur in a particular installation. If this equipment does cause interference to radio or television reception, which can be determined by turning the equipment off and on, the user is encouraged to try to correct the interference by one or more of the following measures:

- Reorient the receiving antenna
- Relocate the NES with respect to the receiver
- Move the NES away from the receiver.
- Plug the NES into a different outlet so that Control Deck and receiver are on different circuits.

If necessary, the user should consult the dealer or an experienced radio/television technician for additional suggestions. The user may find the following booklet prepared by the Federal Communications Commission helpful:

How to Identify and Resolve Radio-TV Interference Problems. This booklet is available from the U.S. Government Printing Office, Washington, D.C. 20402, Stock No. 004-000-00345-4.

The NES Files

<http://www.nesfiles.com>

© 1989 AMERICAN SAMMY CORPORATION

LICENSED BY NINTENDO®
FOR PLAY ON THE



The NES Files

<http://www.nesfiles.com>

PRINTED IN JAPAN